

Vehicle Information	
Year	2024
Make	Dodge
Model	RAM 1500

Enclosure Information	
Design Type	6 th Order Series-Tuned Bandpass
Placement	Truck Bed
Orientation	Position the enclosure with the vent directed into the main cabin.



AUDIO DYNAMICS

Special Notes	
Mount the subs with the motors protruding into the two smaller chambers.	

Amplifier Information	
Continuous Power Handling	3,000 W
Subsonic Filter Setting	40 Hz
Low Pass Filter Setting	50 Hz

Subwoofer Information	
Make	Audio Dynamics
Model	AD4215 D4
Quantity	2

Performance Information	
SQ	Within the Vehicle
SQL	Outside the Vehicle
✓ SPL	✓ Metering Position

Metering Information			
✓ Headrest	Peak Frequency	42.27 Hz	
Dash / Windshield			
Foot Well			

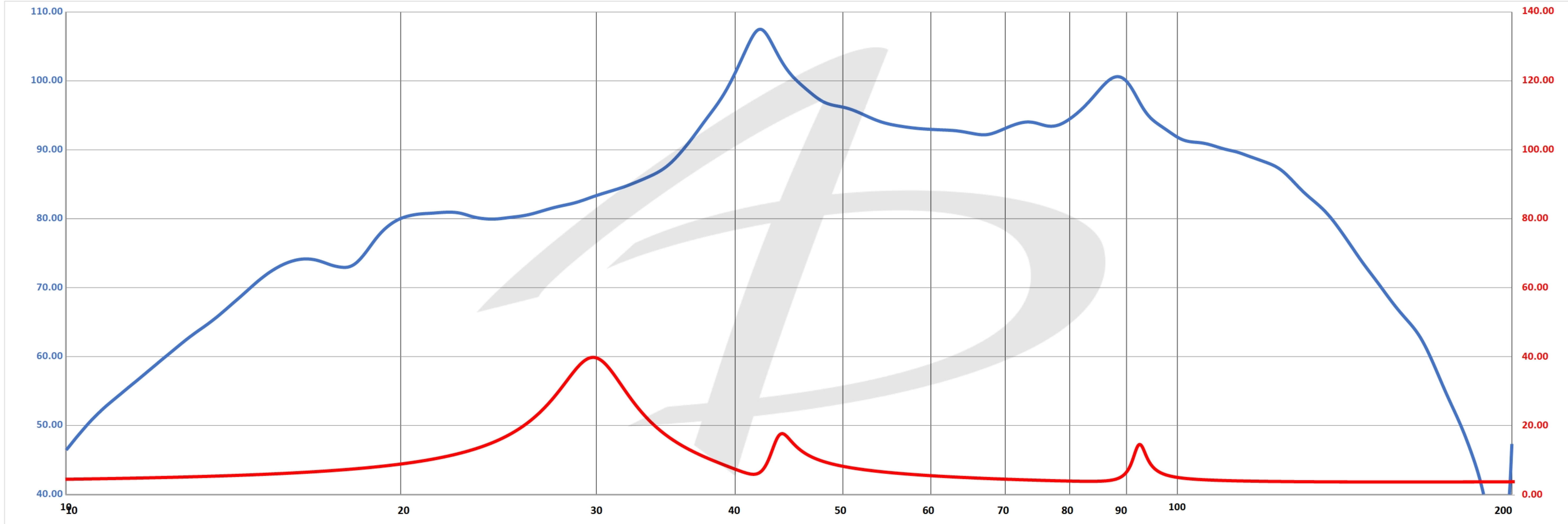

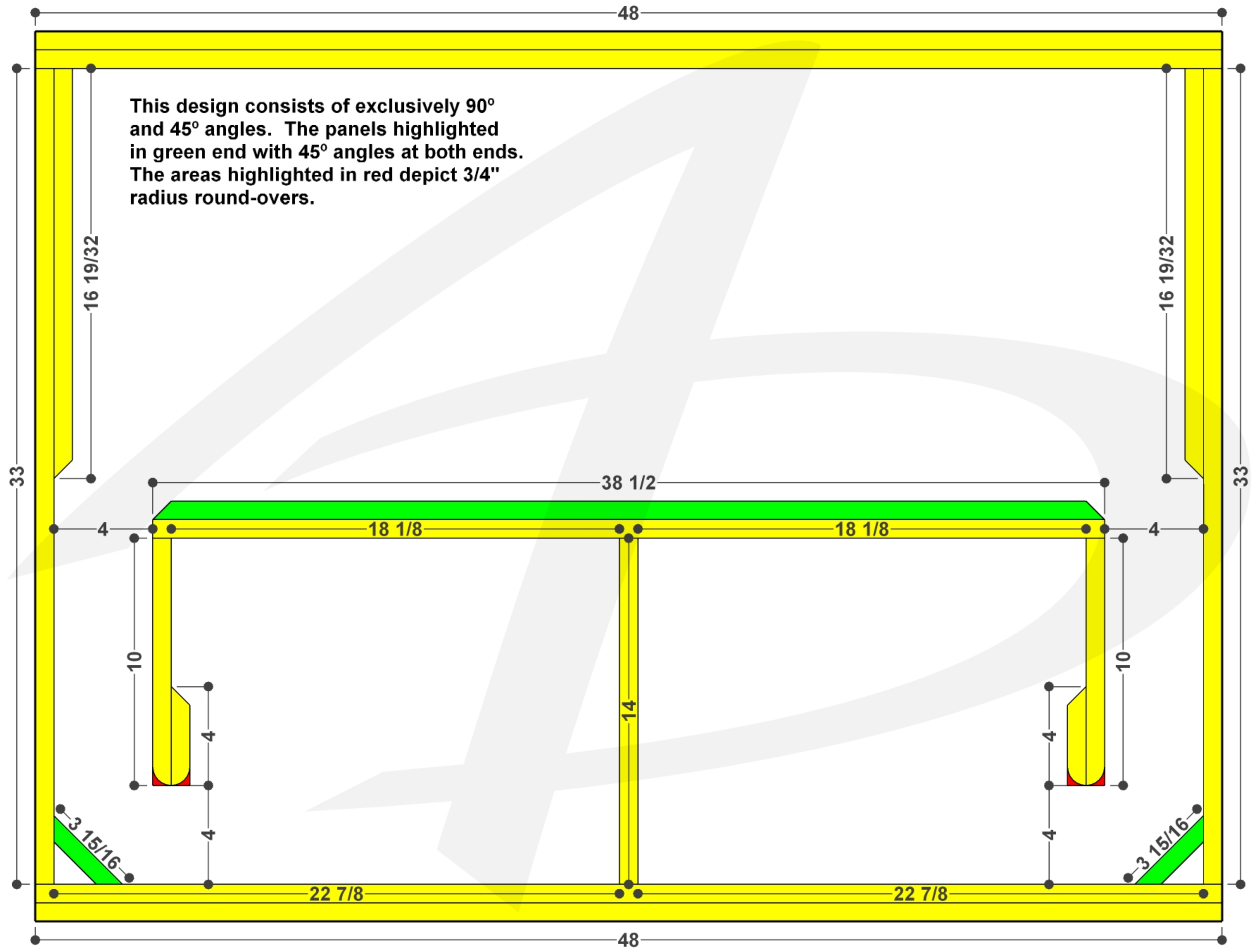

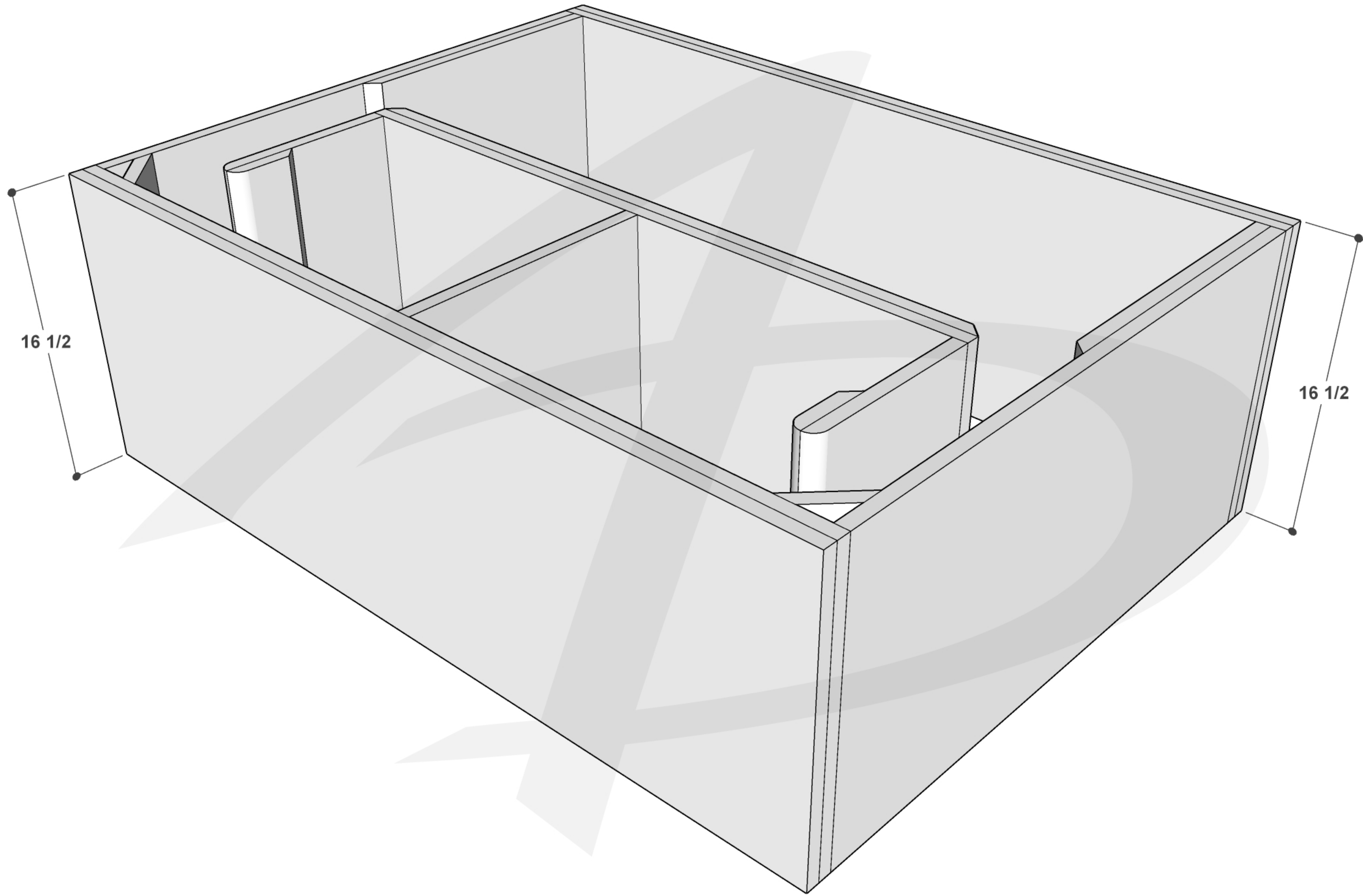

16 1/2

16 1/2

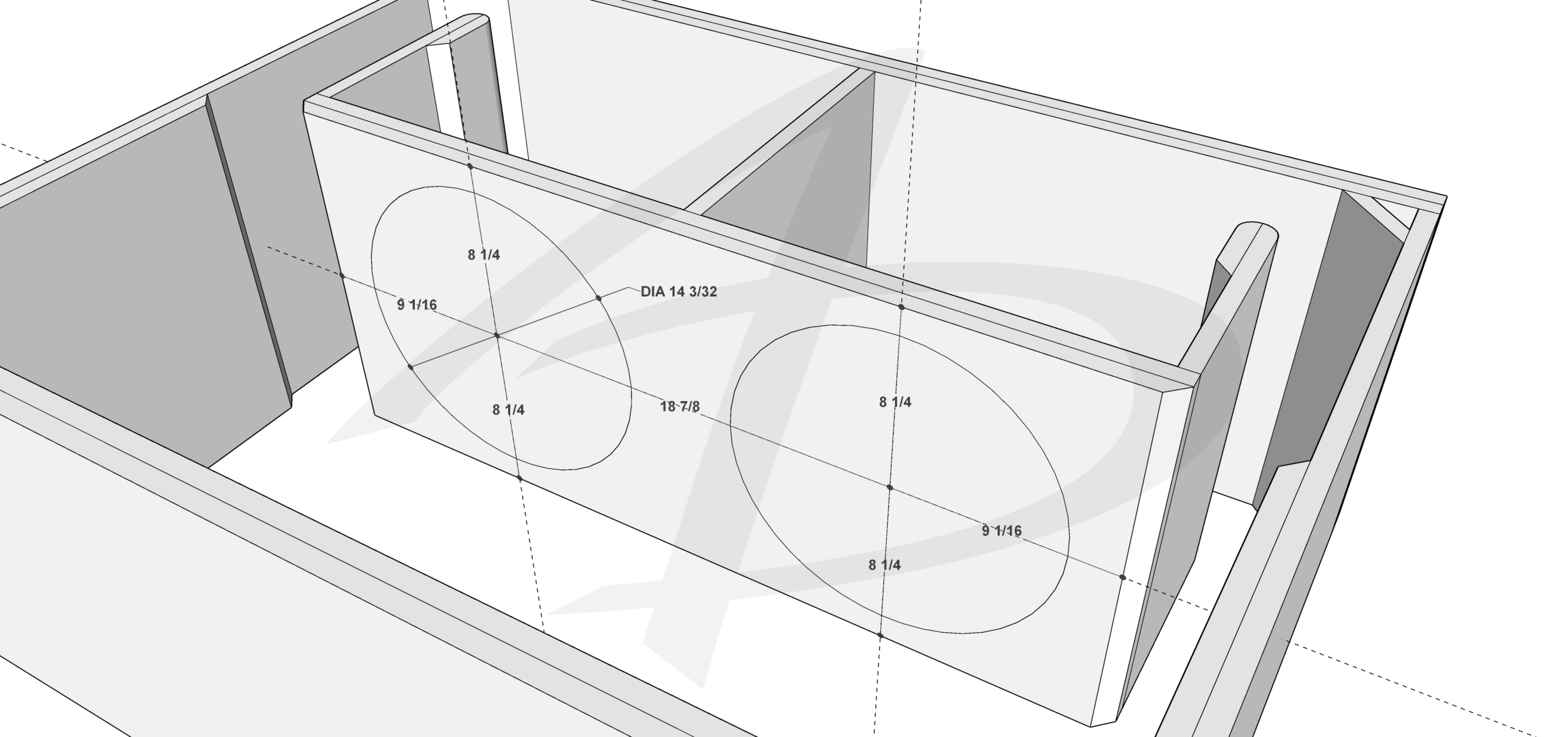

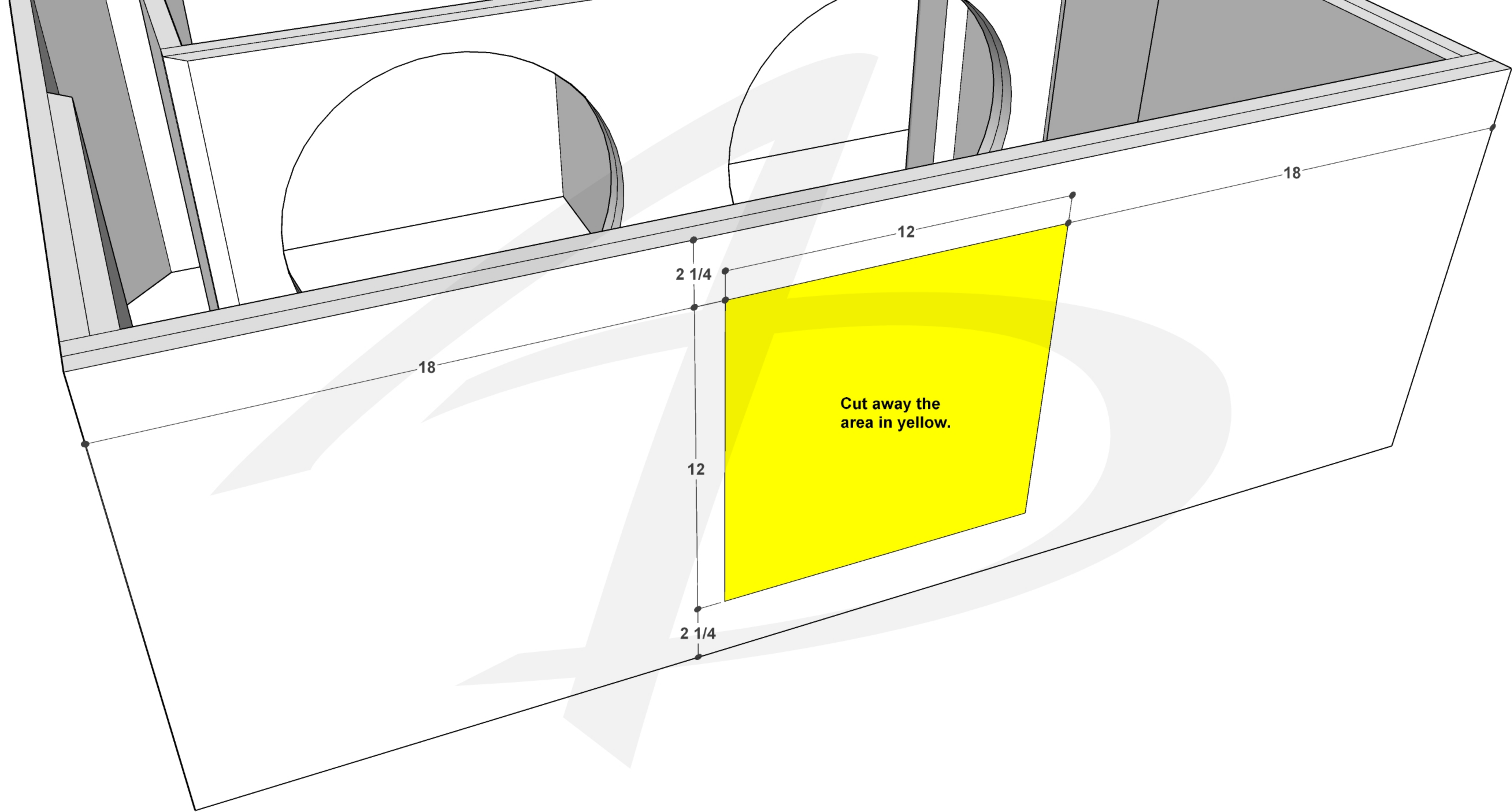

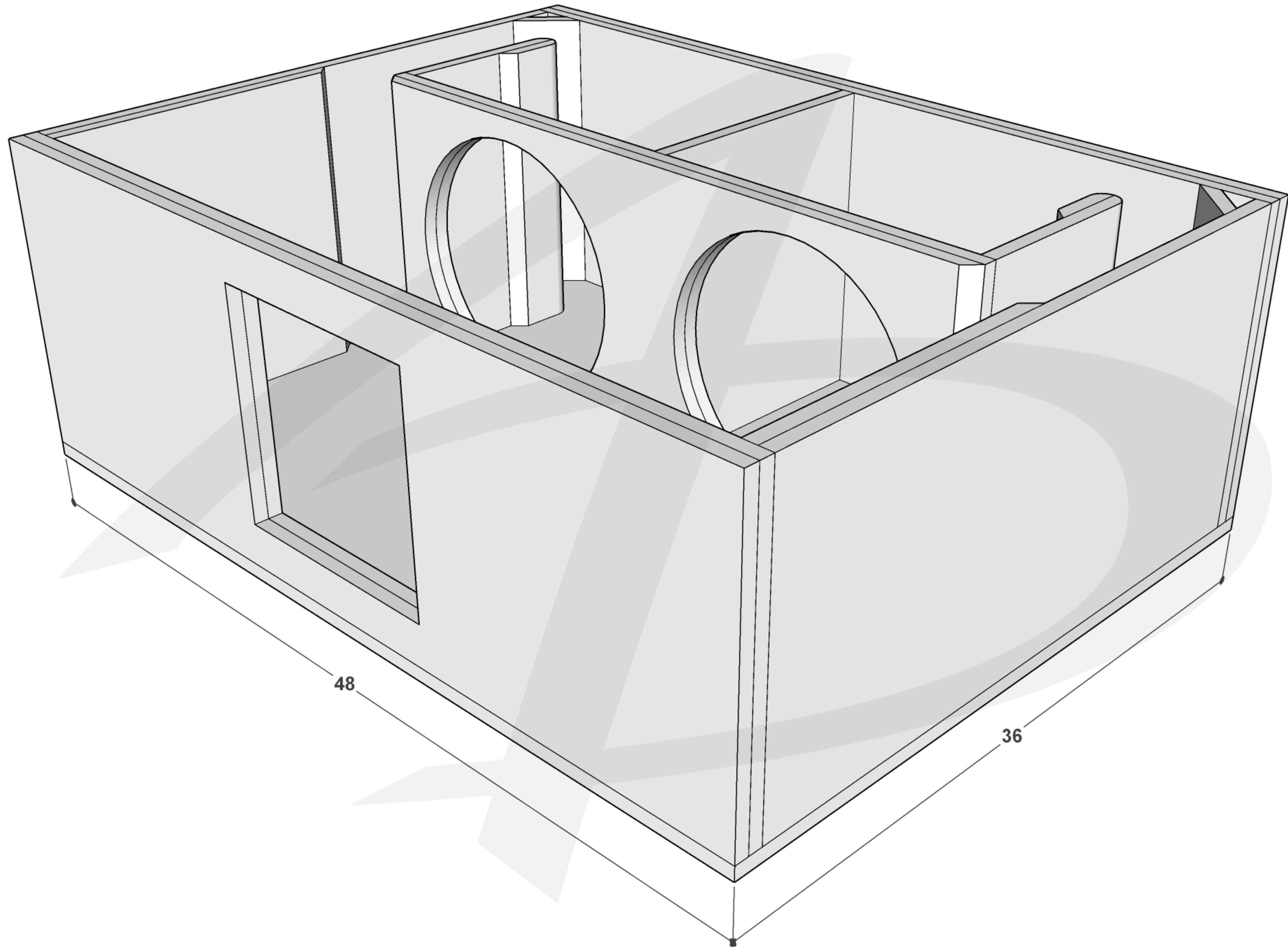

48

36

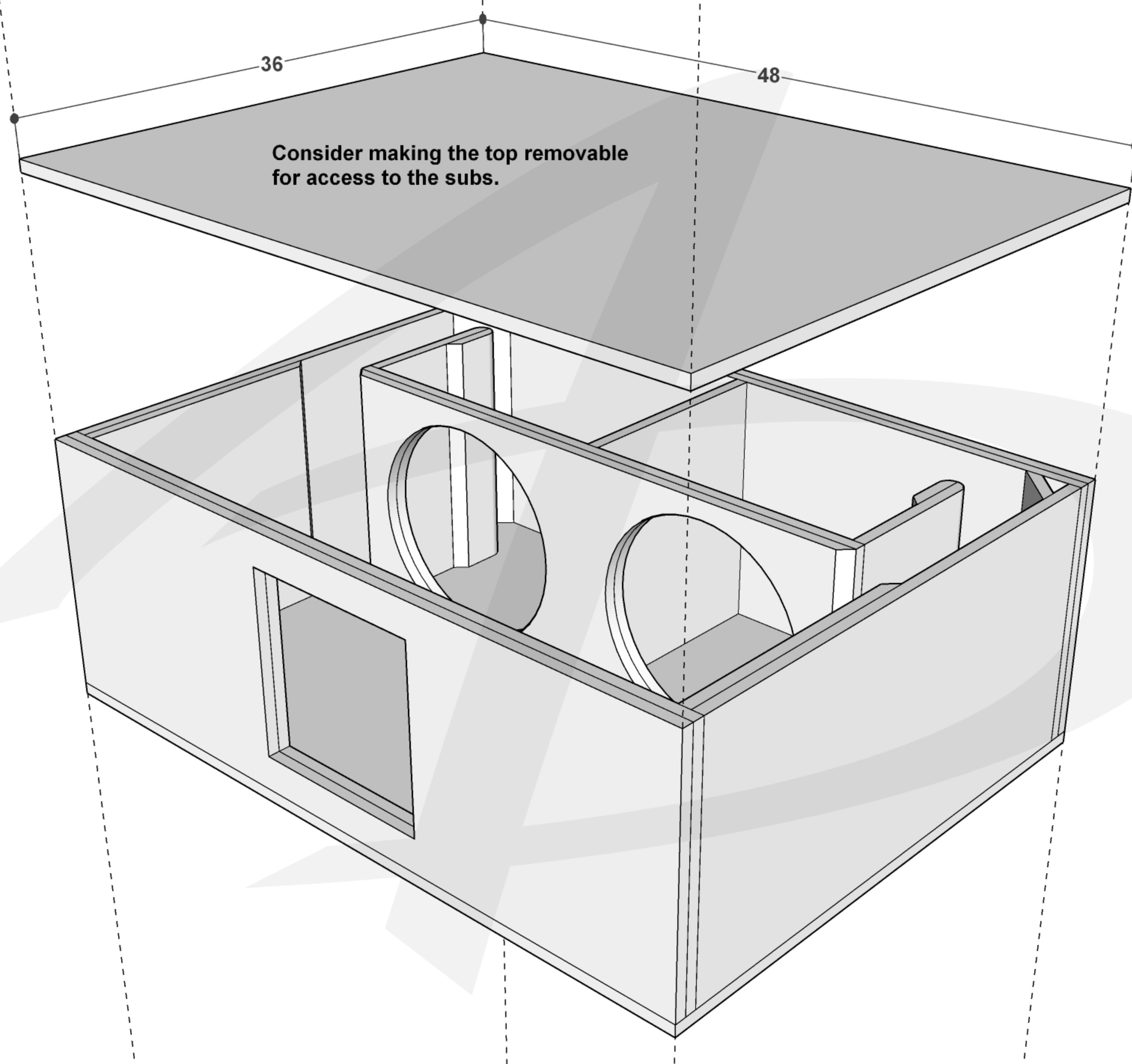

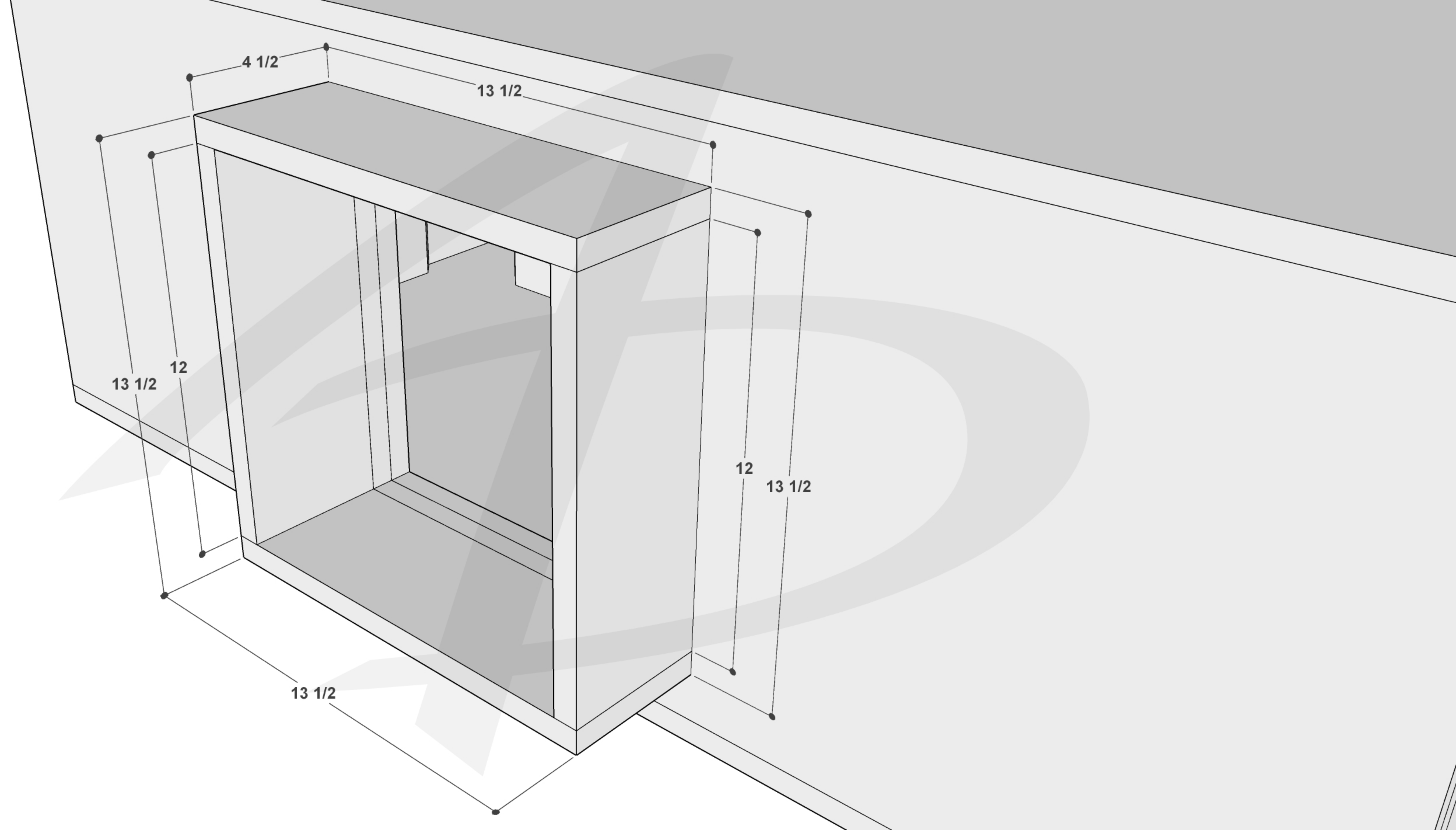

$4\frac{1}{2}$

$13\frac{1}{2}$

$13\frac{1}{2}$

12

$13\frac{1}{2}$

12

$13\frac{1}{2}$

