

Vehicle Information	
Year	2023
Make	GMC
Model	Sierra Denali 2500

Enclosure Information	
Design Type	6 th Order Series-Tuned Bandpass
Placement	Truck Bed
Orientation	Position the enclosure with the vent directed into the main cabin.



AUDIO DYNAMICS

Special Notes
Mount the subs with the motors protruding into the two smaller chambers.

Amplifier Information	
Continuous Power Handling	6,000 W
Subsonic Filter Setting	24 Hz
Low Pass Filter Setting	65 Hz

Subwoofer Information	
Make	Audio Dynamics
Model	AD4215 D2
Quantity	4

Performance Information	
SQ	<input checked="" type="checkbox"/> Within the Vehicle
<input checked="" type="checkbox"/> SQL	Outside the Vehicle
SPL	Metering Position

Metering Information		
Headrest	Peak Frequency	Hz
Dash / Windshield		
Foot Well		

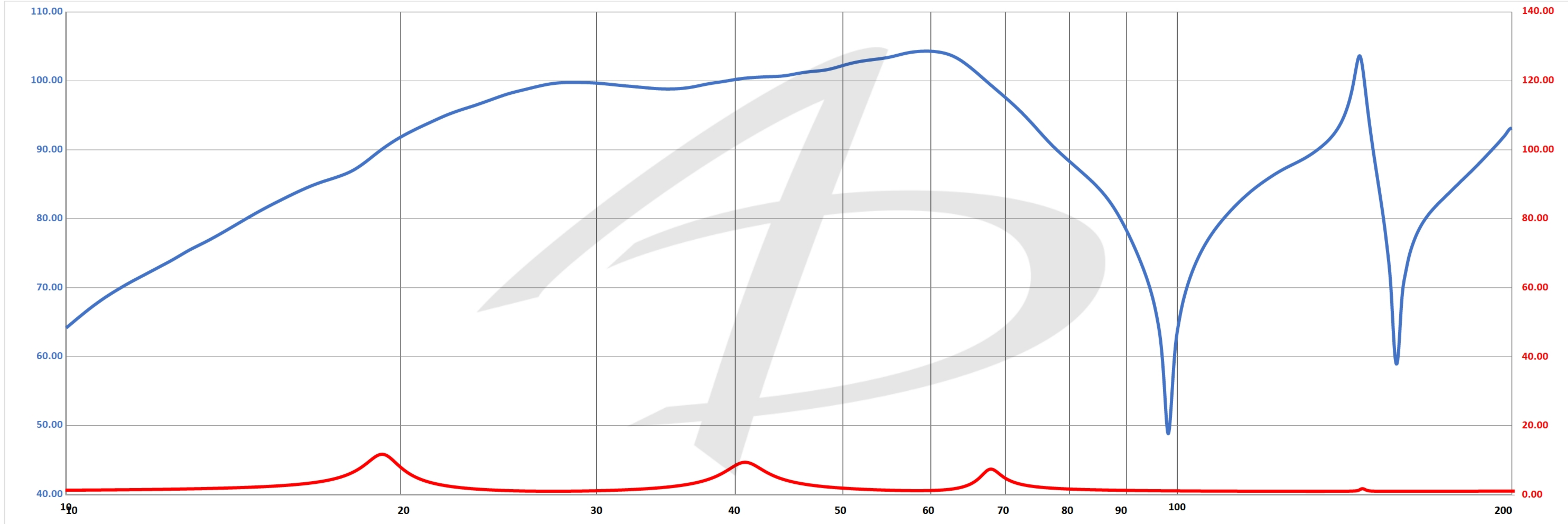

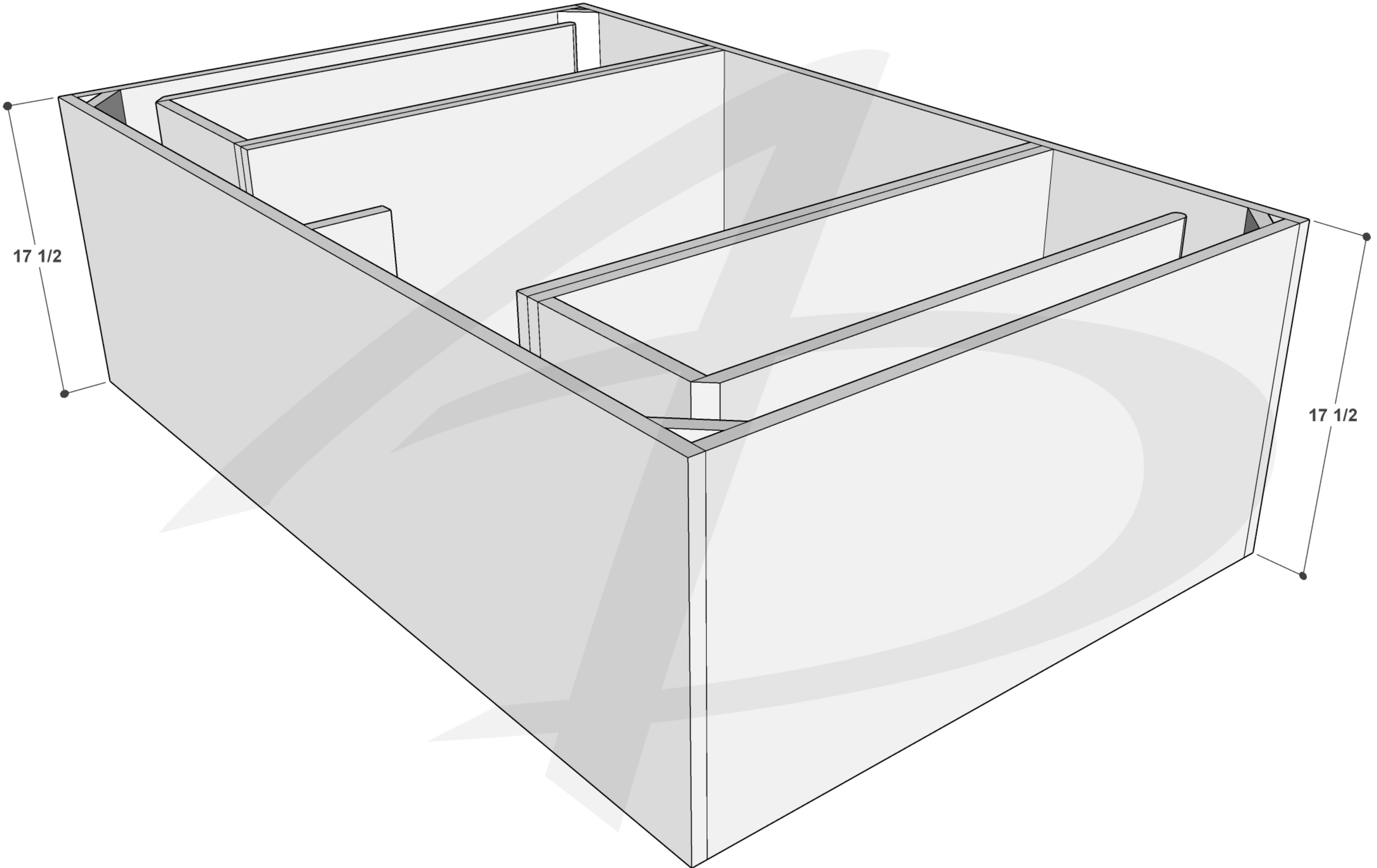

17 1/2

17 1/2

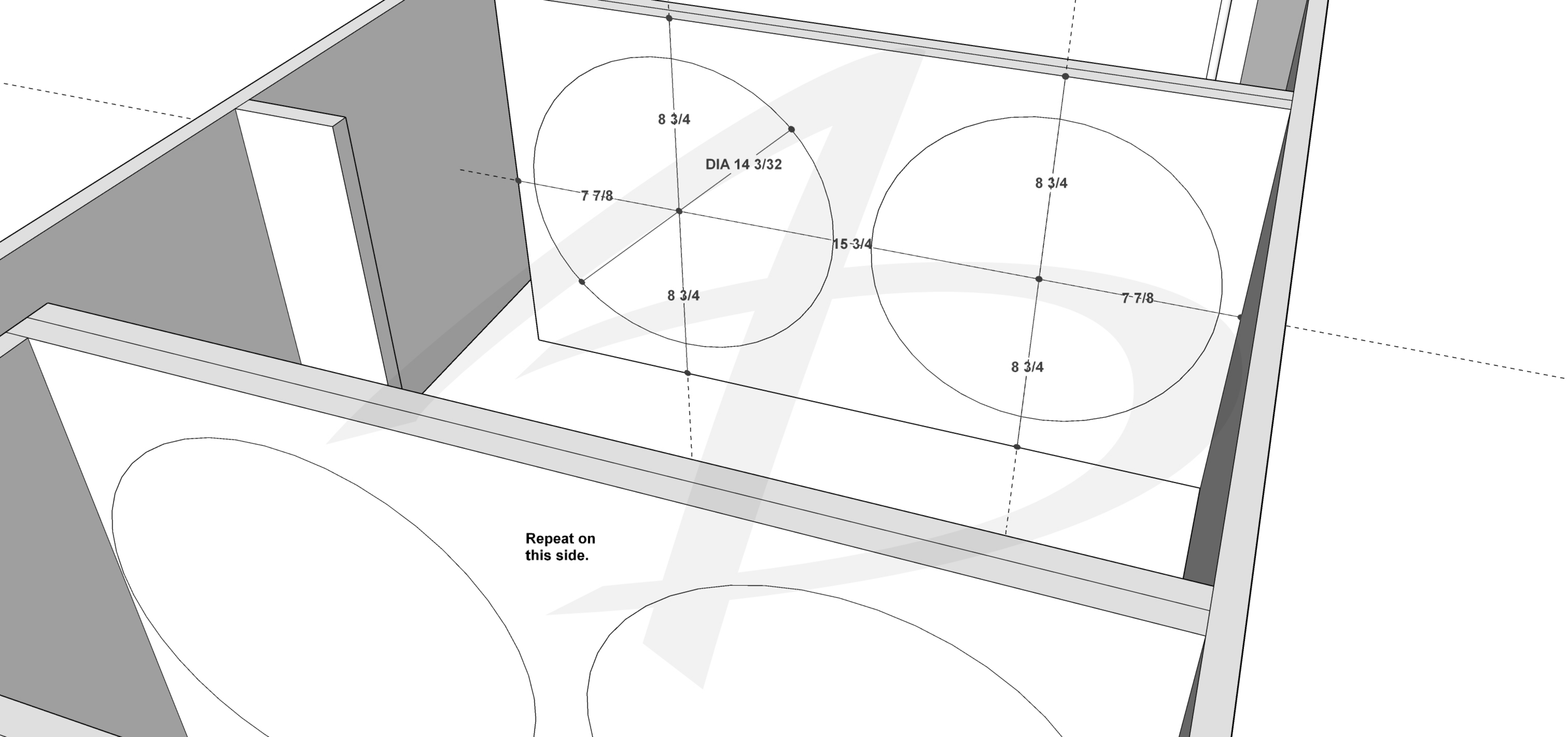

**Repeat on
this side.**

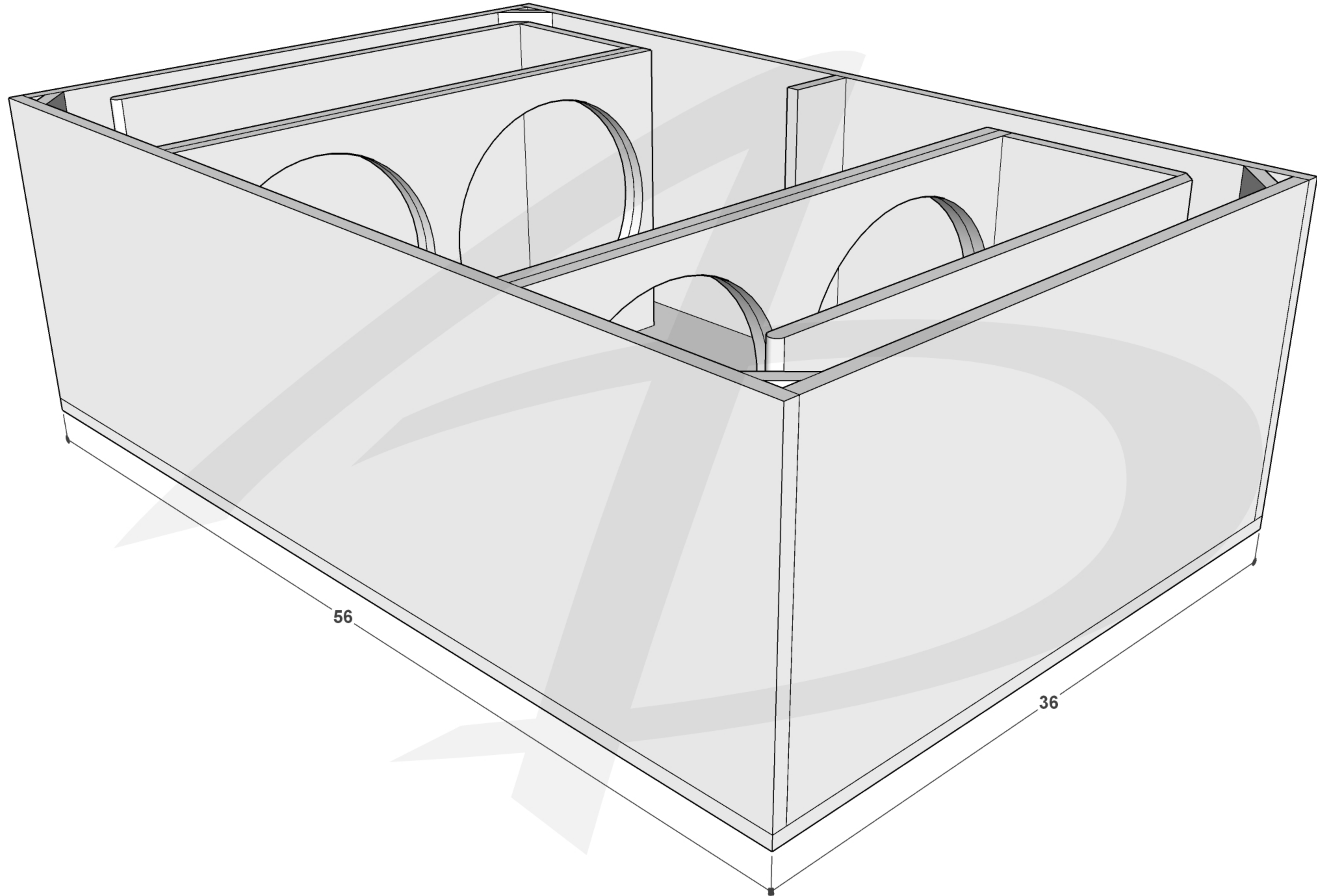

56

36

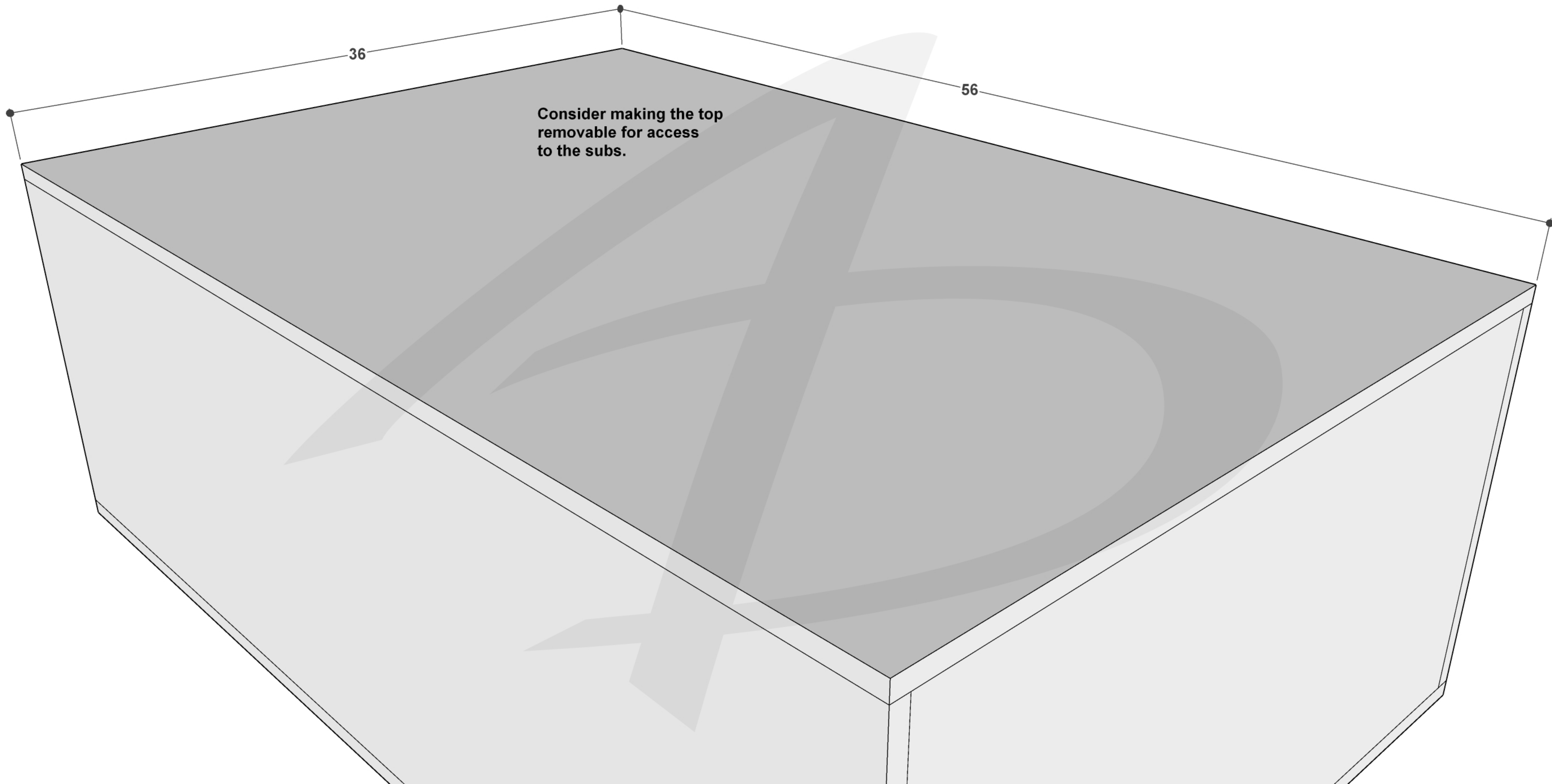

36

56

Consider making the top
removable for access
to the subs.

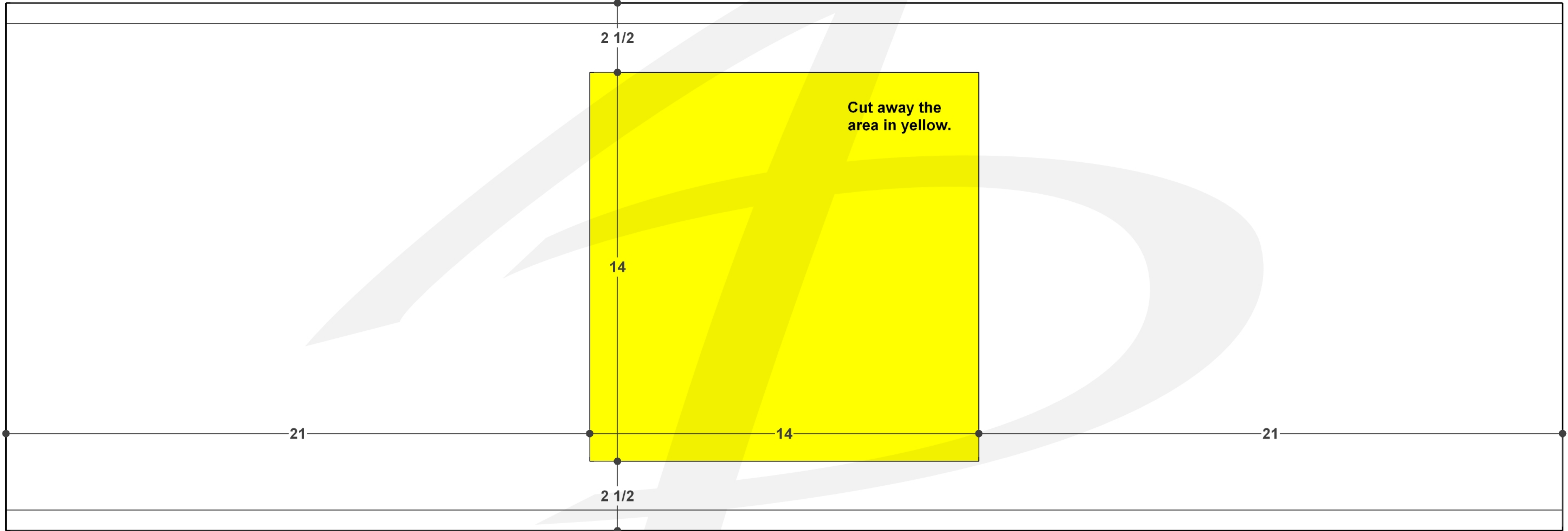

2 1/2

Cut away the
area in yellow.

14

21

14

21

2 1/2

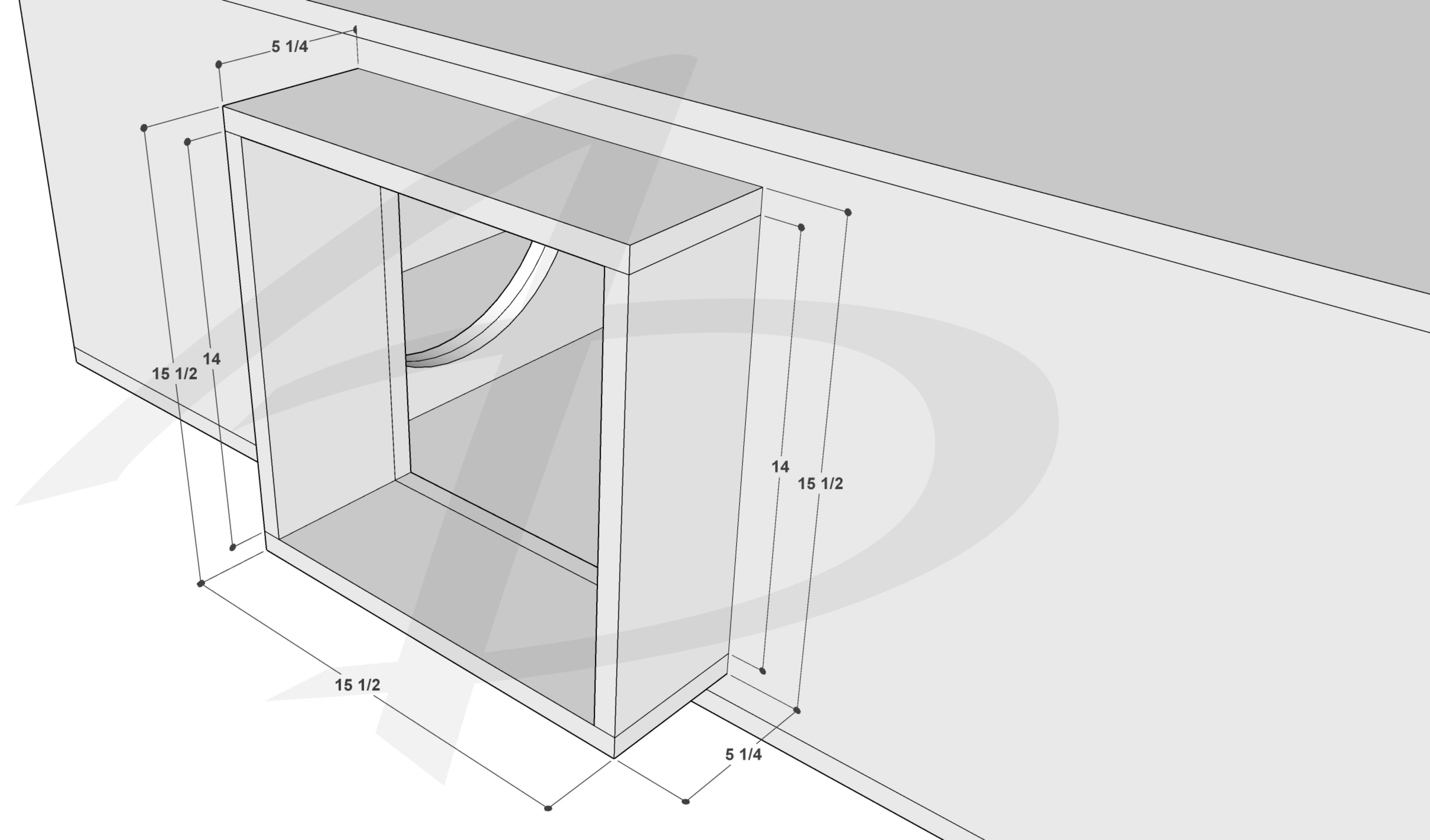

5 1/4

15 1/2

14

15 1/2

5 1/4

14

15 1/2

